

# RUGIA

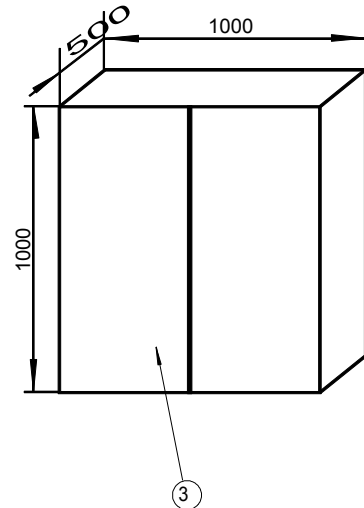
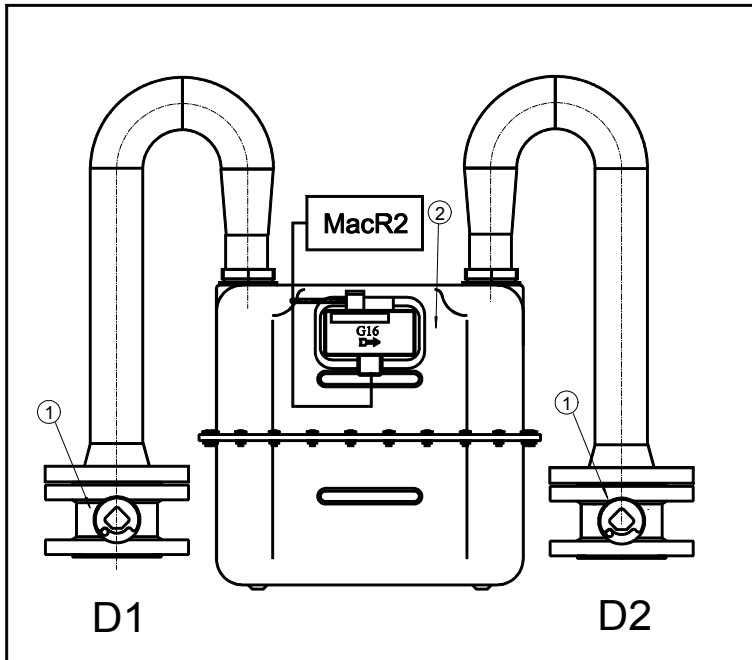

## OPIS:

1. kurek kulowy DN50 EFAR
2. gazomierz miechowy G16N SCHLUMBERGER z rejestratorem MacR2
3. szafka z blach malowanych proszkowo

D1=50 D2=50	Nazwa rys. PUNKT POMIAROWY GAZU Q=25 Nm <sup>3</sup> /h P1 = P2 = 2,0 kPa	RUGIA SP. Z O.O. SPÓŁKA KOMANDYTOWA <b>RUGIA</b> 65-021 ZIELONA GÓRA UL. DĄBROWSKIEGO 41A TEL. (068) 324 51 71 FAX (068) 324 55 48
KATALOG URZĄDZEŃ		